

PURELL ES™ EVERYWHERE SYSTEM INSTALLATION INSTRUCTIONS

These instructions apply to the PURELL ES Everywhere System.

Please carefully read all instructions before installing and using the dispenser.
Failure to follow instructions may cause damage to mounting surfaces.



Wall Mount Instructions

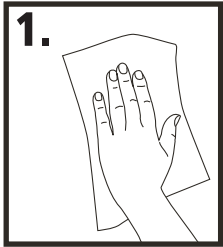

Clean surface with isopropyl alcohol. **Do not use household cleaners.**

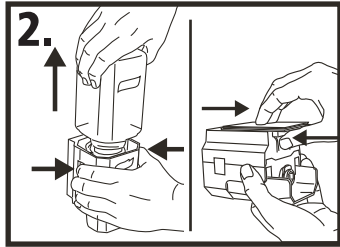

Remove refill by depressing right and left release buttons. Remove mount plate by depressing release lever behind push bar and sliding mount plate. Set refill and base aside.

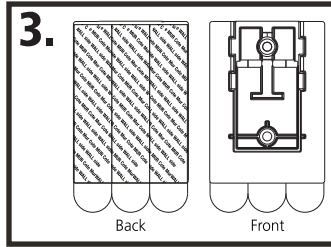

Remove RED liner from three Command® Strips and press each firmly on mount plate with tabs extending below edge as shown.

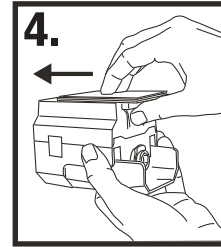

Slide Mounting Plate onto base.

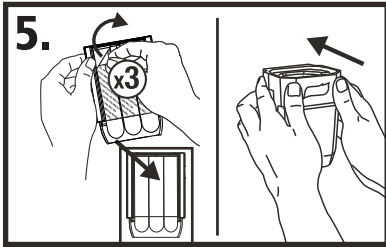

Remove BLACK liner from three Command Strips and place base on surface. Press firmly for 30 seconds.

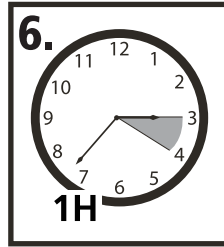

Allow the base to set for 1 hour.

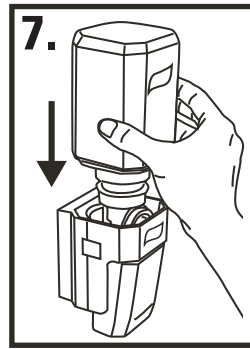

Slide refill into base until refill locks in place.

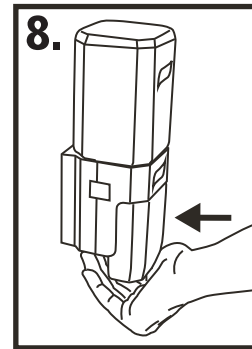

Depress push bar several times until product is dispensed.

System Removal

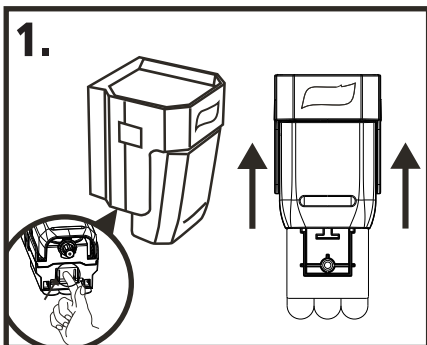

Depress release lever behind push bar and slide base off mount plate.

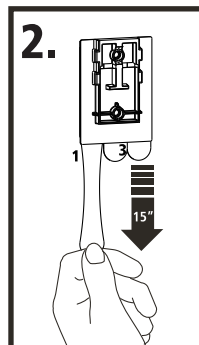

Pull tab on outside Command strip #1 straight down (slowly) for 15 inches or until strip releases from wall. Repeat for strip #3.

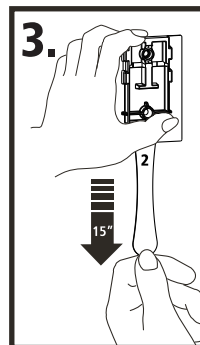

Hold mount plate gently and pull remaining Command strip #2 tab straight down (slowly) for 15 inches or until strip releases.

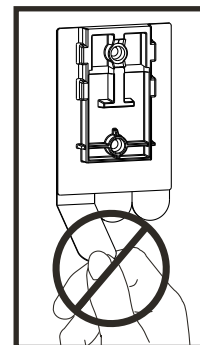

Command® Strips are a product of 3M. For further information visit command.com. 3M and Command are trademarks of 3M. © 3M 2010. All Rights Reserved.



Never pull the Command strip towards you. This will cause the strip to break off.

If the Command strip breaks:
1. Heat the mount plate with a hair dryer to soften the adhesive.
2. Use dental floss to gently cut through the foam to remove the mounting plate from the surface. Stretch or peel the remaining adhesive.

DO NOT ATTEMPT TO PRY THE PLATE OFF THE SURFACE, AS DAMAGE MAY RESULT.

Surface & Temperature Recommendation

The system can be adhered to: painted, stained or varnished wood, tile, painted cinder block, plaster, metal, and painted wallboard.

Paint must be fully cured (check cure time with paint manufacturer) before using Command® Strips. We suggest waiting a week before use on fresh paint. Alcohol may remove or dull the surface of fresh paint.

When adhering system to surface, temperature must be above 50°F (10°C) and below 105°F (40°C).

For humid locations use water resistant Command Strips.

For alternate surfaces the system can be secured using two #6 x 1 inch long pan head self-tap screws and two #6 x 7/8 inch long plastic anchors.



Surface Mount Instructions

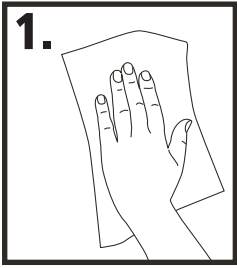

1. Clean surface before adhering mount solution to the horizontal surface

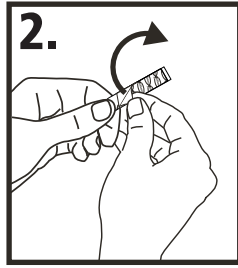

2. Peel the paper from red Command side of the first strip

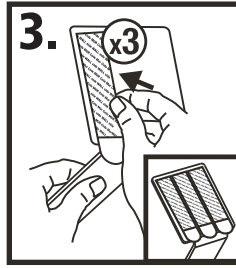

3. One at a time, adhere the Command strips to the bottom of the surface mount leaving the entire rounded and non-adhesive edge extending beyond the edge of the metal mount. This will allow for easy removal if necessary. Repeat this 2 times for the remaining Command strips



4. Peel the protective paper from the wall side of each command strip

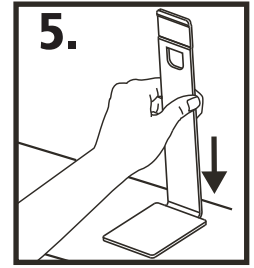

5. Place the mount against the surface in the desired location and firmly press

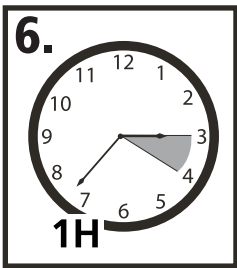

6. Allow the command strips to set for 1 hour before loading base and refill

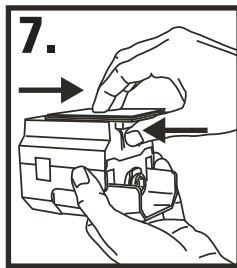

7. Press the release lever located on the bottom of the base; slide off the wall plate

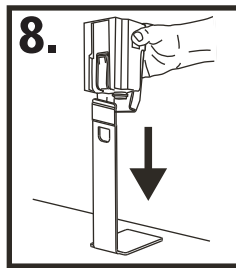

8. Slide base onto the surface mount making sure there is an audible click when the base is in place

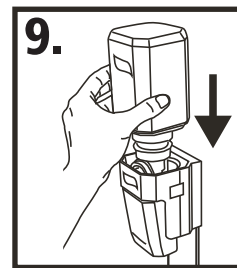

9. Load refill into the base with the PURELL label facing out making sure there is an audible click when the refill is in place

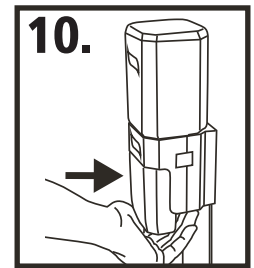

10. Pump the push bar on the base until fully primed and PURELL Advanced Instant Hand Sanitizer is dispensed.



Rail Mount Instructions

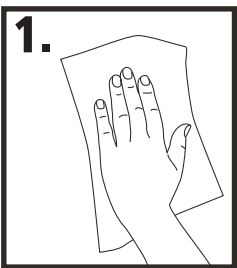

1. Clean surface before adhering mount solution to the horizontal surface

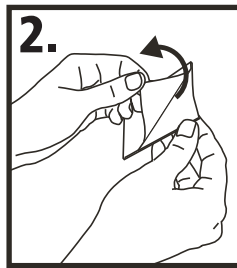

2. Peel the protective paper off of the double sided tape

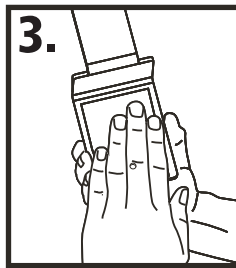

3. Adhere to the inside of the vertical face of the rail mount

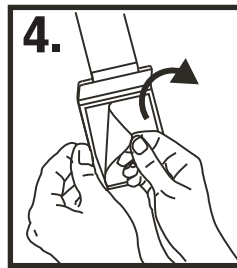

4. Peel the protective paper from the other side of double sided tape

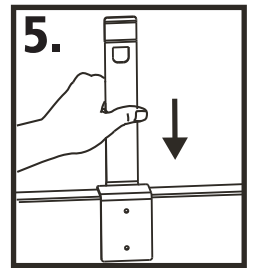

5. Place the mount against the surface in the desired location and firmly press

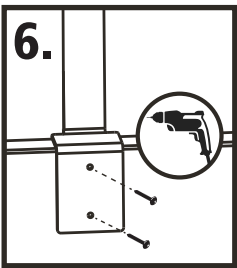

6. Use the provided self-tapping screws and a drill to secure rail mount into the vertical surface

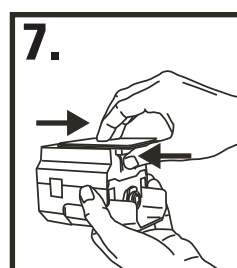

7. Press the release lever located in the bottom of the base and slide off the wall plate

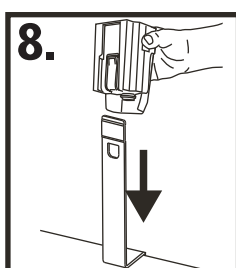

8. Slide base onto the rail mount making sure there is an audible click when the base is in place

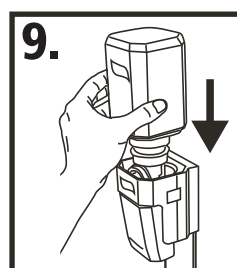

9. Load refill into the base with the PURELL label facing out making sure there is an audible click when the refill is in place

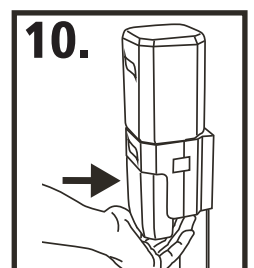

10. Pump the push bar on the base until fully primed and PURELL Advanced Instant Hand Sanitizer is dispensed



GOJO Industries, Inc.
One GOJO Plaza, Suite 500
P.O. Box 991 • Akron, OH 44309-0991
Tel: 1-330-255-6000 • Toll-free: 1-800-321-9647
Fax: 1-800-FAX-GOJO