



NEED FUNCTIONAL  
OFFICE FURNITURE?  
**SURE THING.**



**GRAND&TOY**  
An OfficeMax Company

Furniture solutions from people who understand Government.

# LOOKING TO CREATE AN INSPIRING FUNCTIONAL WORKPLACE THAT MEETS STANDING OFFER REQUIREMENTS AND BUDGET? SURE THING.

A functional office environment can be the point of difference your department needs to retain and engage staff and operate more efficiently. Enjoy more choice, expert service and better overall value for all your furniture needs, with one reliable source. We have the expertise and a team of dedicated Business Solutions Advisors who understand your unique procurement policies and procedures. Through our standing offers for seating and filing cabinets, as well as our authorized re-seller status on various leading manufacturer standing offers, you're able to purchase responsibly with Grand & Toy.

## GRAND & TOY STANDING OFFERS

OEM INK & TONER	RMSO STANDING OFFER	EXPIRY DATE
National Capital Region	E60PD - 100003/006/PD	31/03/2012
New Brunswick & P.E.I.	E60PD - 100003/006/PD	31/03/2012
Nova Scotia	E60PD - 100003/006/PD	31/03/2012
G&T REMANUFACTURED INK & TONER	RMSO STANDING OFFER	EXPIRY DATE
Pacific - BC & YK	E60PD - 090004/006/PD	30/06/2012
PAPER - Single Award Non Aboriginal	RMSO STANDING OFFER	EXPIRY DATE
National Capital Region	E60PD - 100001/001/PD	31/03/2012
Ontario	E60PD - 100001/001/PD	31/03/2012
Quebec	E60PD - 100001/001/PD	31/03/2012
Western - AB, MB, NU, NWT & SK	E60PD - 100001/001/PD	31/03/2012
New Brunswick & P.E.I.	E60PD - 100001/001/PD	31/03/2012
Nova Scotia	E60PD - 100001/001/PD	31/03/2012
Newfoundland & Labrador	E60PD - 100001/001/PD	31/03/2012
Seating	E60PQ-030004/034/PQ	13/3/2012
Filing & Storage	E60PQ-070005/004/PQ	13/3/2012

## SELECTION SUMMARY

As an authorized partner for the following manufacturer National Master Standing Offers, only Grand & Toy offers a national network of Furniture Specialists that provide interiors solutions completely addressing Government specifications.



<p><b>SEATING</b> E60Q-030004/006/PQ</p> <p><b>FILING &amp; STORAGE</b> E60PQ-070005/002/PQ</p> <p><b>PANELS</b> E60PQ-090001/001/PQ E60PQ-080005/005/PQ</p> <p><b>FREESTANDING HEIGHT ADJUSTABLE TABLES</b> E60PQ-090004/004/PQ</p>	<p><b>SEATING</b> E60Q-030004/007/PQ</p> <p><b>FILING &amp; STORAGE</b> E60PQ-070005/005/PQ</p> <p><b>PANELS</b> E60PQ-080005/003/PQ E60PQ-090001/002/PQ E60PQ-090002/003/PQ</p> <p><b>LAMINATE &amp; WOOD CASEGOODS</b> E60PQ-090004/009/PQ</p> <p><b>FREESTANDING HEIGHT ADJUSTABLE TABLES</b> E60PQ-090004/009/PQ</p>	<p><b>SEATING</b> E60PQ-030004/029/PQ</p> <p><b>FILING &amp; STORAGE</b> E60PQ-070005/007/PQ</p> <p><b>PANELS</b> E60PQ-080005/002/PQ</p> <p><b>FREESTANDING HEIGHT ADJUSTABLE TABLES</b> E60PQ-090004/005/PQ</p>
--	--	---

**WHAT IS GREENGUARD INDOOR AIR QUALITY CERTIFICATION?**

A third-party verification for low-emitting products. The program identifies specific products that have been tested and continue to be tested to ensure that their chemical and particle emissions meet acceptable indoor air quality pollutant guidelines and standards. This program is voluntary and available to all manufacturers and their suppliers.

# SELECTION SUMMARY



**LAN RACKING, HEIGHT ADJUSTABLE AND ERGONOMIC PRODUCTS**  
E60PQ-080003/005/PQ

**SEATING**  
E60PQ-030004/009/PQ

**SEATING**  
E60PQ-030004/002/PQ  
(Not available in Quebec City)

**SEATING**  
E60PQ-030004/027/PQ



**FILING & STORAGE**  
E60PQ-070005/010/PQ

**SEATING**  
E60PQ-030004/024/PQ  
  
**HEIGHT ADJUSTABLE TABLES + ERGO ACC.**  
E60PQ-090004/010/PQ

**SEATING**  
E60PQ-030004/031/PQ

**SEATING**  
E60PQ-030004/010/PQ  
(Available in Atlantic Canada only)



**SEATING**  
E60PQ-030004/033/PQ

**SEATING**  
E60PQ-030004/004/PQ

**SEATING**  
E60PQ-030004/032/PQ

**SEATING**  
E60PQ-030004/030/PQ  
(Available in Atlantic Canada only)



**FILING & STORAGE**  
E60PQ-070005/001/PQ

**LAMINATE & WOOD CASEGOODS**  
E60PQ-090004/002/PQ

(Available in Greater Toronto Area only)

**LAMINATE & WOOD CASEGOODS**  
E60PQ-090004/006/PQ

**FREESTANDING HEIGHT ADJUSTABLE TABLES**  
E60PQ-090004/006/PQ

**SEATING**  
E60PQ-030004/020/PQ

# LOOKING FOR SPECIFIC STANDING OFFER INFORMATION IN YOUR REGION?

CHECK OUT:

[grandandtoy.com/governmentcanada](http://grandandtoy.com/governmentcanada)



## SEATING

With a breathable mesh back and contemporary design, these chairs combine both comfort and style to support you through your workday. A mesh back supports the spine and provides breathability and increased comfort for long work hours. All products on pages 4 & 5 are Greenguard certified except for Bouty - 4003BU1/SS/99.









### TEKNION - CONTESSA



## SEATING

From reception to boardroom and everywhere in between, these office chairs are perfect for maintaining a uniform look, throughout the office. Choose a chair with adjustable features to accommodate your own body proportions and working style.

<p><b>GLOBAL - GRANADA w/SHUKRA</b></p>  <p>GLOBAL</p>	<p><b>GLOBAL - SONIC</b></p>  <p>GLOBAL</p>	<p><b>GLOBAL - SUPRA</b></p>  <p>GLOBAL</p>	
<p><b>ERGOCENTRIC - GEO-HB-MT</b> Available in Atlantic Canada only</p>  <p>ergoCentric SEATING SYSTEMS</p>	<p><b>LACASSE - SAVVY</b></p>  <p>GROUPE LACASSE</p>	<p><b>GRAND &amp; TOY - CA3088</b></p>  <p>G&amp;T GRAND&amp;TOY.</p>	<p><b>BOUTY - 4003BU1/SS/99</b> Not available in Quebec City</p>  <p>Bouty</p> <p>**This product is not Greenguard certified</p>

## EXTENSIVE SELECTION

The items in this guide are only a snapshot of the selection available to federal customers. Be sure to speak with your dedicated Grand & Toy Furniture Specialist to explore our wider selection of furniture solutions that suit your unique needs.

# SEATING

Striking designs. Innovative features. Enduring comfort.  
Designed with your work environment in mind.



All products on this page are Greenguard certified except for Borgo Jendra.

  <p><b>NEUTRAL POSTURE - SAHARA</b></p>	  <p><b>NIGHTINGALE - CXO6200D</b></p>	  <p><b>KEILHAUER - TOM</b></p>
--	---	---

**BORGO - JENDRA**



\* this product is not Greenguard certified



**KI - ENGAGE**



**OFFICE STAR - 2300 SPACE**



**Humanscale - F112**



**ADI - VOILA**



**Horizon - 270-03-AT-MT203**







Check out our online  
**Ergonomic Solutions** guide  
for a snapshot of our  
best value selection!

[grandandtoy.com/governmentcanada](http://grandandtoy.com/governmentcanada)



## EXTENSIVE SELECTION

The items in this guide are only a snapshot of the selection available to federal customers. Be sure to speak with your dedicated Grand & Toy Furniture Specialist to explore our wider selection of furniture solutions that suit your unique needs.

# FILING & STORAGE

Smart filing and storage solutions that promote efficiency, functionality and style!

## OFFICE SPECIALTY - 9900 SERIES

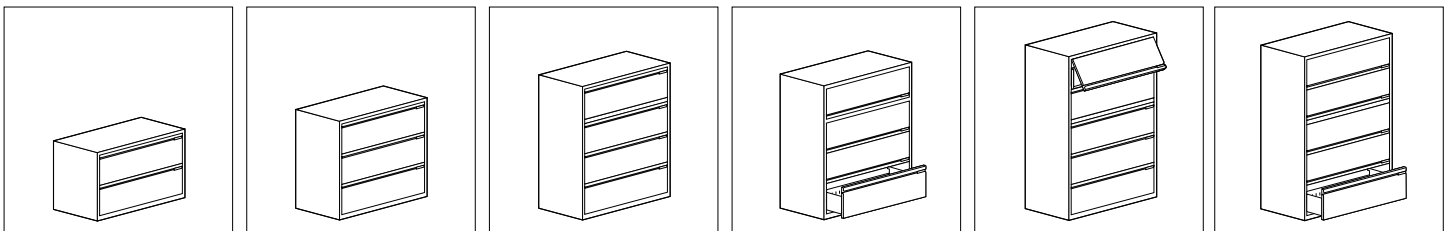

INTERIORS | TECHNOLOGY | OFFICE SUPPLIES | PROFESSIONAL SERVICES | FACILITY SUPPLIES | IMAGING

## FILING & STORAGE

2-drawer or 4-drawer—Maximizing value with organizational solutions that meet government standing offer specifications and your filing and storage needs.

**GRAND & TOY - G99-L363/G99-L302/G99-L362**



**GRAND & TOY®**  
An OfficeMax Company

**GRAND & TOY - 99-2BFRCW/99-2BFLCW**



**GRAND & TOY - G99-L365/G99-L425/G9936-4R1H/G9936-5R1H/G99-L364/  
G99-L424/G9942-4R1H/G9942-5R1H**



**GRAND & TOY - G99T-2BFL/G99T-2BFR**

### EXTENSIVE SELECTION

The items in this guide are only a snapshot of the selection available to federal customers. Be sure to speak with your dedicated Grand & Toy Furniture Specialist to explore our wider selection of furniture solutions that suit your unique needs.



All products on this page are Greenguard certified



You deal with confidential information. For solutions to keep your vital information safe and secure, visit [grandandtoy.com/governmentcanada](http://grandandtoy.com/governmentcanada) for our Federal Government Security Solutions Guide.

**TEKNION - OVERVIEW FILING**



Teknion

**ARTOPEX - METAL FILING**



**GLOBAL - 9100 PLUS LATERAL FILING**



**LACASSE - STEEL LATERAL FILING**



WANT THE BEST  
VALUE FOR YOUR  
PRINT ROOM NEEDS?  
**SURE THING.**

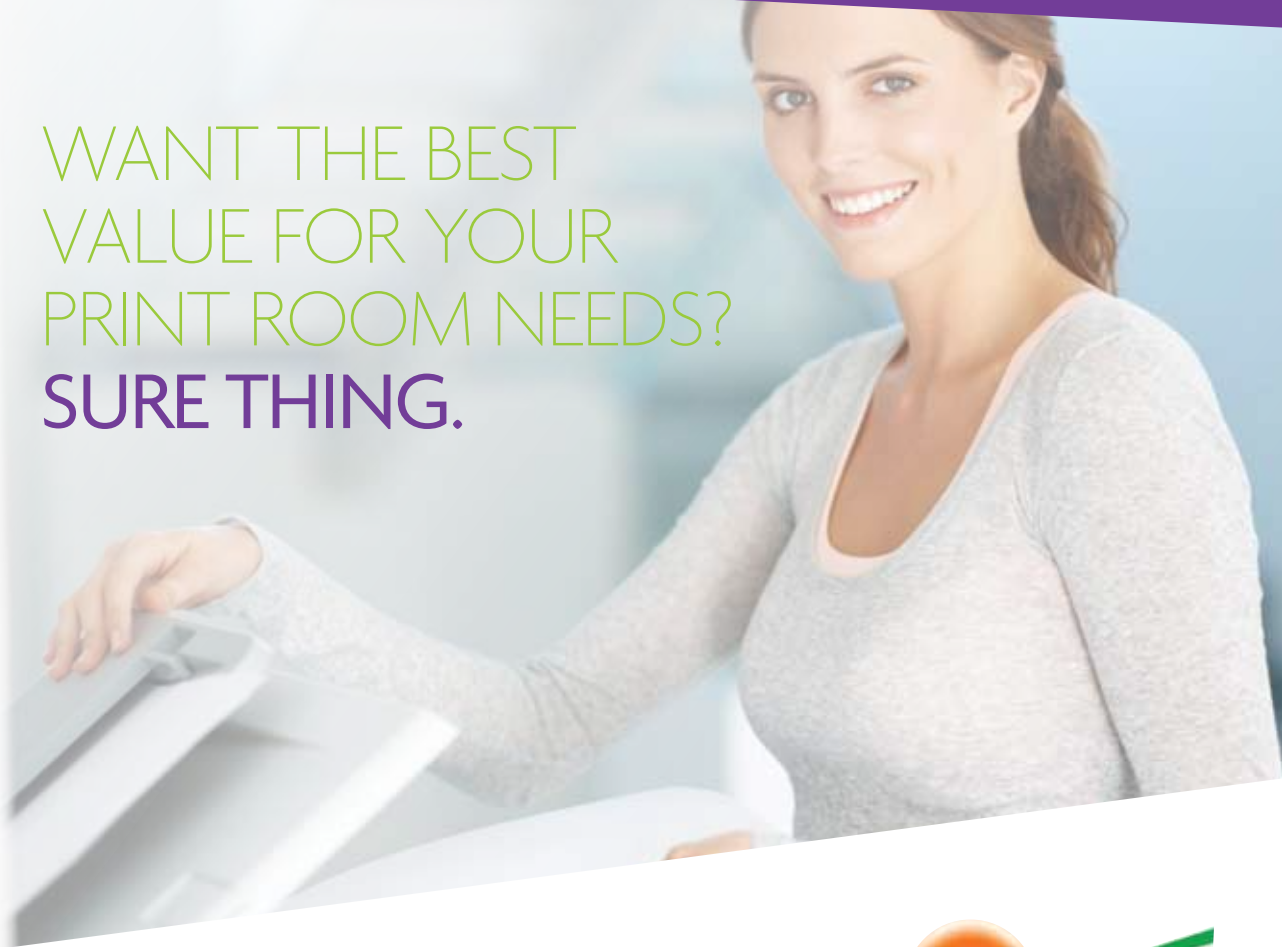

Check out our online **Print Room Solutions** guide for a snapshot of our Federal Government Standing Offer selection!

[grandandtoy.com/governmentcanada](http://grandandtoy.com/governmentcanada)



## EXTENSIVE SELECTION

The items in this guide are only a snapshot of the selection available to federal customers. Be sure to speak with your dedicated Grand & Toy Furniture Specialist to explore our wider selection of furniture solutions that suit your unique needs.

## SYSTEMS & PANELS

Need a consistent look, but have diverse needs between departments or locations? Sure thing. Our office systems offer the flexibility to meet style and function, while delivering value and meeting the requirements of standing offers.

**TEKNION - TOS**  
(Remanufactured panels from Teknion TOS series also available)

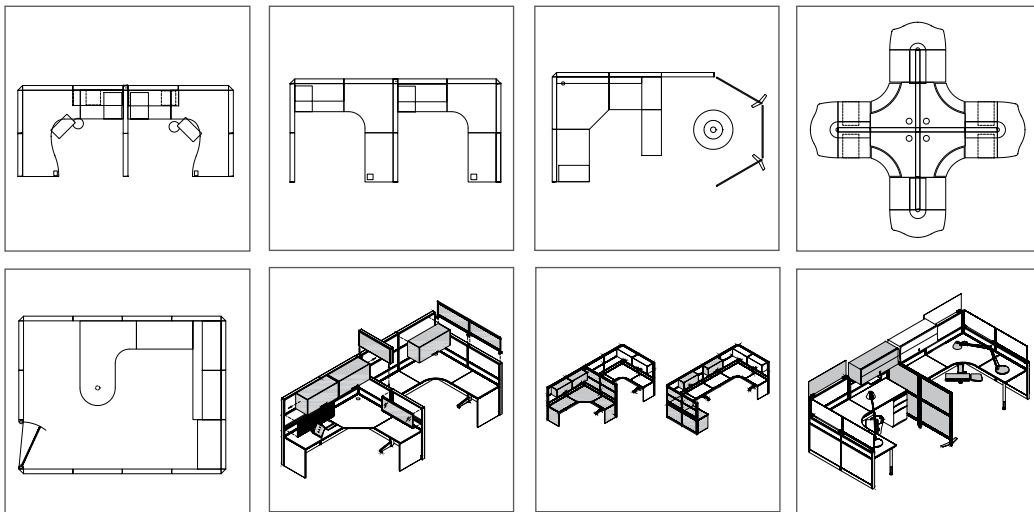



All products on pages 12 & 13 are Greenguard Indoor Air Quality Certified

**LACASSE - NVISION**



**GLOBAL - BOULEVARD 3**



**TEKNION - LEVERAGE**



**EXTENSIVE SELECTION** The items in this guide are only a snapshot of the selection available to federal customers. Be sure to speak with your dedicated Grand & Toy Furniture Specialist to explore our wider selection of furniture solutions that suit your unique needs.

## LAMINATE & WOOD CASEGOODS

The perfect design, layout and furniture combine to create a space that provides freedom from the distractions within open areas of the office. Grand & Toy can help you create a space that works for you.

**ARTOPEX -ACCENT**



All products on this page are Greenguard Indoor Air Quality Certified

**TEKNION - EXPANSION**



Teknion



## FREESTANDING HEIGHT ADJUSTABLE TABLES

Height adjustable tables provide flexibility, comfort, collaboration and improved ergonomics. Encourage a healthy workplace by varying your working position throughout the day.

ISE - ST RES-2-2460



GROUPE LACASSE - QUORUM



GLOBAL



TEKNION - COMPLEMENTS



HUMANSCALE - ST RES-2-2460



All products on this page are  
Greenguard Indoor Air Quality Certified

### EXTENSIVE SELECTION

The items in this guide are only a snapshot of the selection available to federal customers. Be sure to speak with your dedicated Grand & Toy Furniture Specialist to explore our wider selection of furniture solutions that suit your unique needs.

## ERGONOMIC ACCESSORIES

Functional. Ergonomic. Efficient. Workplace legislation encourages a safe and healthy working environment. These ergonomic essentials help reduce common office injuries and enhance workplace performance.



Visit [grandandtoy.com/governmentcanada](http://grandandtoy.com/governmentcanada) to download our complete Federal Government Ergonomic Guide

**HUMANSCALE - ELEMENT**



Humanscale

**HUMANSCALE - M2**



Humanscale

**TEKNION - COMPLEMENTS**



Teknion

**ISE - LEADER6**



ISE

**ISE - MA-I-S-G**



ISE

**HUMANSCALE - 5G**



Humanscale



## WE KNOW OFFICE FURNITURE, WE UNDERSTAND GOVERNMENT

As Canada's only true national contract furniture supplier, Grand & Toy offers the industry's largest network of Interiors Specialists to support you—providing you with the expertise and efficiency to handle your projects of every scope and scale.

As seasoned professionals with a lengthy history of working with the government, we have the background to deliver the essentials you rely on daily. In addition to furniture we have everything from technology, facility supplies and promotional products, to a wide range of solutions to meet your print room, ergonomic & security needs.

Order efficiently? *Sure thing.*

[grandandtoy.com/governmentcanada](http://grandandtoy.com/governmentcanada)



**EXTENSIVE SELECTION** The items in this guide are only a snapshot of the selection available to federal customers. Be sure to speak with your dedicated Grand & Toy Furniture Specialist to explore our wider selection of furniture solutions that suit your unique needs.

# TO OBTAIN A QUOTE OR TO DISCUSS YOUR NEXT FURNITURE ORDER, EMAIL THE LOCAL G&T FURNITURE SPECIALIST TEAM IN YOUR REGION:

## BRITISH COLUMBIA

Victoria, BC  
Vancouver, BC  
BCFurniture@grandandtoy.com

## CALGARY

Calgary, AB  
CalgaryFurniture@grandandtoy.com

## EDMONTON

Edmonton, AB  
Fort McMurray, AB  
EdmontonFurniture@grandandtoy.com

## PRAIRIES

Regina, SK  
Saskatoon, SK  
Winnipeg, MB  
Thunder Bay, ON  
PrairiesFurniture@grandandtoy.com

## NORTHERN ONTARIO

Sudbury, ON  
Timmins, ON  
North Bay, ON  
New Liskeard, ON  
NorthONFurniture@grandandtoy.com

## SW ONTARIO

London, ON  
Waterloo, ON  
Hamilton, ON  
SouthwestONFurniture@grandandtoy.com

## GREATER TORONTO AREA

Vaughan, ON  
GTAfurniture@grandandtoy.com

## EASTERN ONTARIO

Kingston, ON  
Ottawa, ON  
EastONFurniture@grandandtoy.com

## QUEBEC

Montréal, PQ  
Bureau Spec/Montréal, PQ  
Quebec City, PQ  
QuebecFurniture@grandandtoy.com

## ATLANTIC

Moncton, NB  
Fredericton, NB  
Dartmouth, NS  
Mount Pearl, NFLD  
AtlanticFurniture@grandandtoy.com

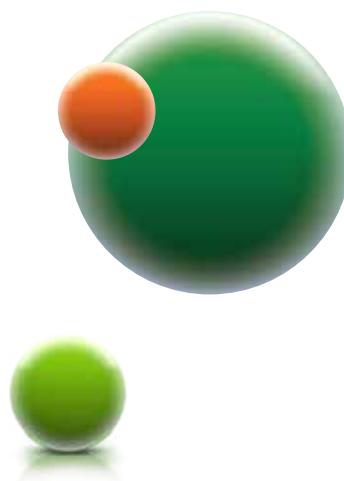

FOR MORE INFORMATION ON THE NATIONAL MASTER STANDING OFFERS IN YOUR REGION VISIT:

[grandandtoy.com/governmentcanada](http://grandandtoy.com/governmentcanada)

